

# *The* GUIDE TO LIGHTING *for* NEW *and* EXISTING POOLS

*The definitive LED Pool Lighting resource for pool builders, technicians and retail professionals.*



**NEW**  
**InstaTouch™**  
**SMART LIGHTING**  
**CONTROLLER**

**AQUA-QUIP PRODUCTS ARE MADE IN AUSTRALIA AND NOW DISTRIBUTED WORLDWIDE**

INSTATOUGH SMART LIGHTING CONTROLLER	3
CONTROLLER COMPATIBILITY	4
EVO2 LED NICHE LIGHTS	5
EVOMAX LED NICHE LIGHTS	6
EVOFG LED LIGHTS FOR FIBREGLASS POOLS	7
QC SERIES LED SURFACE MOUNTED LIGHTS	8
PRODUCT ID GUIDE FOR RETRO-FIT LIGHTS	9
EVO SERIES RETRO-FIT NICHE LIGHTS	10-13
TRANSFORMERS	14
VIVID 360 POOL LIGHT - USA	15
PHOTOMETRY	16
JET-VAC AUTOMATIC POOL CLEANER	17
SALTMATE CHLORINATORS/TWISTER	18
FLOW CONTROL PRO+ / BOOSTER PUMPS	19
DISTRIBUTORS	20



*Aqua-Quip LED Pool Lights are proudly made in Australia.*

*We're passionate about our products and continually strive to exceed our customers' expectations through product innovation and exceptional customer service.*

**AQUA QUIP**

AUTOMATIC POOL CLEANERS (AUSTRALIA) PTY LTD  
 40 PERCY STREET, AUBURN 2144  
 NSW AUSTRALIA  
 P: +612 9643 8338  
 F: +612 9643 8448  
 E: [aqua@aquaquip.com.au](mailto:aqua@aquaquip.com.au)  
 W: [www.aquaquip.com.au](http://www.aquaquip.com.au)

# InstaTouch™

**NEW!**  
AVAILABLE  
SUMMER 2018

## SMART LIGHTING CONTROLLER

*Welcome to the world of Instant colour, where Aqua-Quip's spectacular underwater lighting effects are controlled at your fingertips.*

- Intuitive touch-screen wireless handset allows you to instantly select colours for your pool, spa or water feature.
- The wireless handset is robust and water-resistant – whilst retaining a slick and stylish appearance.
- Control two lighting zones independently, with a wireless handset that has extended range.
- Choose from 7 fixed colours and 6 colour shows, or choose and save your own fixed colour.
- No need to replace your existing cables and transformers.
- Enables lights to be dimmed.
- Simple to install, plug and play.



**CONTROLLER COMPATIBLE**



## **Aqua-Quip Multi-Colour LED Pool Lights**

**Evo2 – Niche  
Light for  
Concrete Pools**



**EvoMAX –  
Niche Light for  
Concrete Pools**



**EvoFG –  
Compact Niche  
Light for Fibreglass  
and Vinyl Pools**



**QC Series –  
Surface Mounted LED**

### **Controller Compatible**

*Aqua-Quip LED Pool Lights can be supplied to be operated from the lighting controllers below:*

- **Aqua-Quip InstaTouch**
- **Astral Viron Connect 10  
Connect Lite and Connect Lite+**
- **Pentair Intellitouch and EasyTouch**
- **Hayward OmniLogic**
- **Zodiac AquaLink (available through Zodiac)**



# EVO2 LED UNDERWATER POOL LIGHTS



**Australian Made**

Scan the QR Code on your smartphone to download a colour brochure.

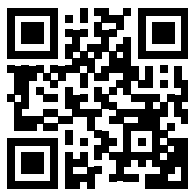

## Aqua-Quip Evo2 LED Pool Light – Dimensions

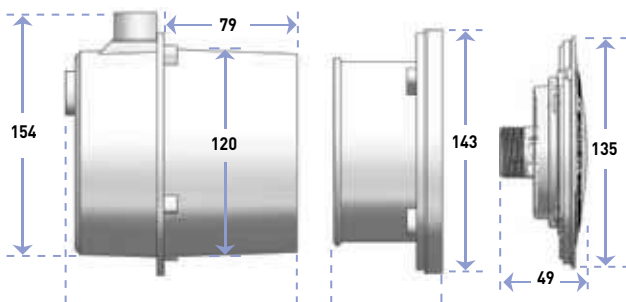

**Evo2 LED** is a modern, compact light with Quick Connect Cable which allows cable and plug kit to be wound up inside the housing whilst the pool is being built.

Evo2 LED Pool Light can be stored in a safe location and only needs to be connected to the cable and plug kit when the pool is ready to be filled. Simply push the plug kit onto the rear of the light and tighten the nut by hand.

The elegance of Evo2 can be enhanced with the addition of the optional Stainless Steel Trim Ring Kit.



## Aqua-Quip Evo2 – Niche Light

<b>Suitable for:</b>	New Concrete Pools, Spas, Water Features, Catch Tanks				
<b>Stainless Steel Option:</b>	Yes, P/N: ASS 056				
<b>Cable Lengths:</b>	20m, 30m, 40m				
<b>Cable Gauge:</b>	0.75mm <sup>2</sup> , 2 core				
<b>Detachable Cable:</b>	Yes, Plug Kit is factory fitted to supply cable				
<b>Operating Voltage:</b>	12v AC				
<b>Rating:</b>	IPX8				
<b>Voltage Tolerance:</b>	+20%, -20%				
<b>Fault Protection:</b>	Thermal cutout. Voltage transient clamping				
	<b>Multi-Colour</b>	<b>Blue</b>	<b>White</b>	<b>Warm White</b>	<b>Green</b>
<b>Power Consumption:</b>	16 VA Max	8 VA	8 VA	8 VA	8 VA
<b>Light Colour:</b>	Various	475 nm	>5000K	3000K	525 nm
<b>Light Output (typical):</b>	Various	180 lm	550 lm	550 lm	500 lm



# EVO MAX LED UNDERWATER POOL LIGHTS

## EvoMAX... Aqua-Quip's premium niche lighting system.



Scan the QR Code on your smartphone to download a colour brochure.



### EvoMAX LED Underwater Pool Light

- Offers maximum illumination whilst preserving a flush profile.
- Stainless Steel Dress Ring available.
- Super bright, energy efficient, long life.
- The innovative Quick Connect Plug Kit is supplied fitted to the cable – allowing the cable to be detached from the pool light, simplifying the installation process.
- Available in fixed colours of white, blue or green as well as the multi-colour option which includes the integrated Colour Selection Palette allowing the user to choose from an infinite variety of fixed colours and programming modes.



### Aqua-Quip EvoMAX LED Pool Light – Dimensions

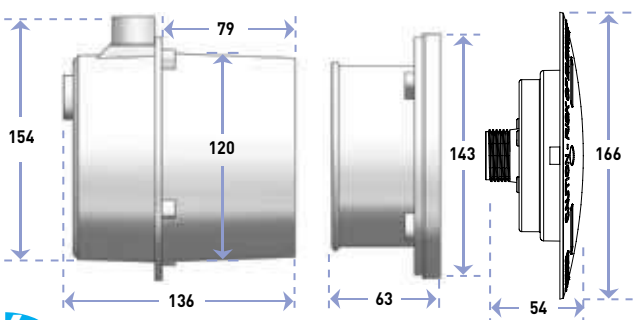

### Aqua-Quip EvoMAX – Niche Light

<b>Suitable for:</b>	New Concrete Pools, Spas, Water Features, Catch Tanks				
<b>Stainless Steel Option:</b>	Yes, P/N: MXA 056				
<b>Cable Lengths:</b>	20m, 30m, 40m				
<b>Cable Gauge:</b>	0.75mm <sup>2</sup> , 2 core				
<b>Detachable Cable:</b>	Yes, Plug Kit is factory fitted to supply cable				
<b>Operating Voltage:</b>	12v AC				
<b>Rating:</b>	IPX8				
<b>Voltage Tolerance:</b>	+20%, -20%				
<b>Fault Protection:</b>	Thermal cutout. Voltage transient clamping				
	<b>Multi-Colour</b>	<b>Blue</b>	<b>White</b>	<b>Warm White</b>	<b>Green</b>
<b>Power Consumption:</b>	30 VA Max	25 VA	25 VA	25 VA	25 VA
<b>Light Colour:</b>	Various	475 nm	>5000K	3000K	525 nm
<b>Light Output (typical):</b>	Various	300 lm	985 lm	985 lm	595 lm



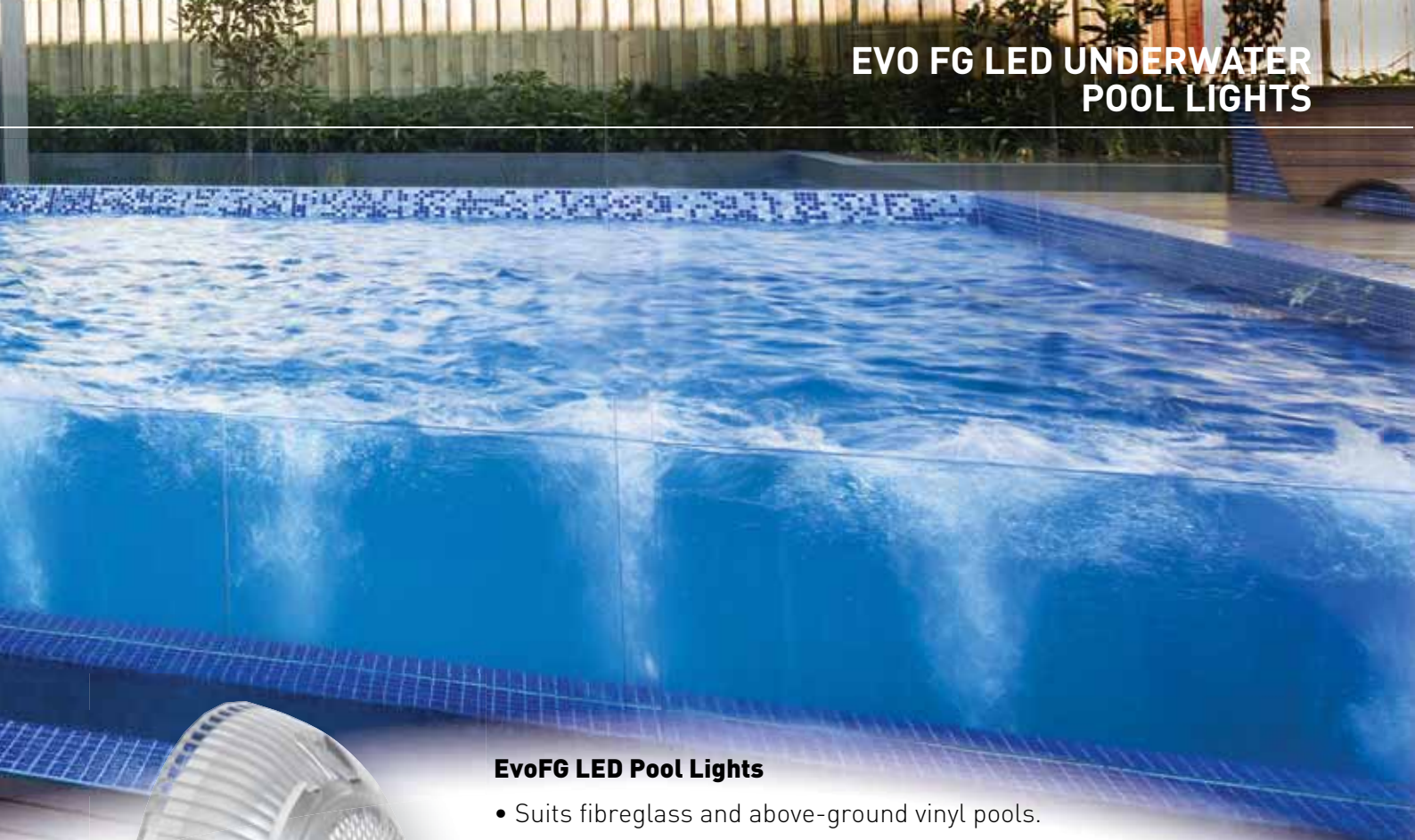

## EvoFG LED Pool Lights

- Suits fibreglass and above-ground vinyl pools.
- Simple to install – fits through a 60mm hole.
- Low profile, compact niche light, supplied with 20m cable.
- 1.2 metres of cable is factory fitted into the niche, allowing the light to be installed below ledges for maximum pool illumination.
- Super bright, energy efficient, long life.
- Available in fixed colours of white, blue or green as well as the multi-colour option which includes the integrated Colour Selection Palette allowing the user to choose from an infinite variety of fixed colours and programming modes.

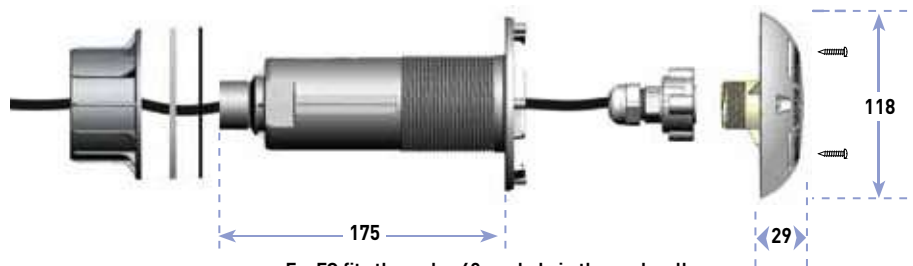

Scan the QR Code on your smartphone to download a colour brochure.



**Australian Made**



### Aqua-Quip EvoFG – Niche Light

<b>Suitable for:</b>	New Fibreglass and A/G Vinyl Pools				
<b>Stainless Steel Option:</b>	No				
<b>Cable Lengths:</b>	20m, 30m				
<b>Cable Gauge:</b>	0.5mm <sup>2</sup> , 2 core				
<b>Detachable Cable:</b>	Yes, Plug Kit is factory fitted to supply cable				
<b>Operating Voltage:</b>	12v AC				
<b>Rating:</b>	IPX8				
<b>Voltage Tolerance:</b>	+20%, -20%				
<b>Fault Protection:</b>	Thermal cutout. Voltage transient clamping				
	<b>Multi-Colour</b>	<b>Blue</b>	<b>White</b>	<b>Warm White</b>	<b>Green</b>
<b>Power Consumption:</b>	16 VA Max	8 VA	8 VA	8 VA	8 VA
<b>Light Colour:</b>	Various	475 nm	>5000K	3000K	525 nm
<b>Light Output (typical):</b>	Various	180 lm	550 lm	550 lm	500 lm

# QC SERIES LED SURFACE MOUNTED LIGHTS FOR NEW POOLS



**Aqua-Quip's QC Series** Surface Mounted Lights are ideal for both new and existing concrete pools.

QC Series LEDs are energy efficient, drawing only 15% of the power requirement of older style halogen lights. QC LED lights incorporate the latest generation LED technology and thermal management system to ensure maximum light output and reliability. QC LED lights are significantly brighter than older 100w halogen systems.

Each QC Series Light is able to be operated from a supply voltage ranging from 12 Volt AC through to 32 Volt AC, thereby utilising the existing transformer.

For new pool construction, choose a 12v transformer from page 14.



**Australian Made**

Scan the QR Code on your smartphone to download a colour brochure.



Aqua-Quip QC Series – Surface Mounted					
<b>Suitable for:</b>	New and existing Concrete Pools				
<b>Stainless Steel Option:</b>	No				
<b>Cable Lengths:</b>	20m, 30m, 40m	<b>For Retro-Fit QC Lights:</b>			
<b>Cable Gauge:</b>	0.75mm <sup>2</sup> , 2 core	No cable supplied			
<b>Detachable Cable:</b>	Yes, Plug Kit is factory fitted to supply cable	The included plug kit is to be connected to the existing cable			
<b>Operating Voltage:</b>	Variable Voltage: 12v AC ~ 32v AC				
<b>Rating:</b>	IPX8				
<b>Voltage Tolerance:</b>	+20%, -20%				
<b>Fault Protection:</b>	Thermal cutout. Voltage transient clamping				
	<b>Multi-Colour</b>	<b>Blue</b>	<b>White</b>	<b>Warm White</b>	<b>Green</b>
<b>Power Consumption:</b>	22 VA Max	16 VA	16 VA	16 VA	16 VA
<b>Light Colour:</b>	Various	475 nm	>5000K	3000K	525 nm
<b>Light Output (typical):</b>	Various	300 lm	1050 lm	1050 lm	650 lm

The QC LED Surface Mounted Retro Fit Light replaces all other brands of lights in concrete pools and a range of popular brands in fibreglass pools. It is supplied with a Universal Mounting Bracket and the unique waterproof Quick Connect Plug Kit that attaches to the existing circular-profile cable.

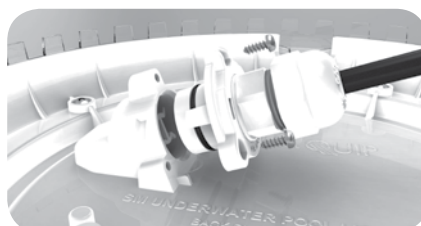

**Step 1.** Fit the plug kit to the existing cable.



**Step 2.** Push into rear of light and tighten screws.

**3**

**NEW!** Metallic-look dress ring.



# Product Identification Guide

Aqua-Quip QC Retro-Fit Lights replace the following brands of Surface Mounted Lights:



Stroud C150 Diameter 210mm



Poolrite Diameter 232mm



Varimode Diameter 211mm

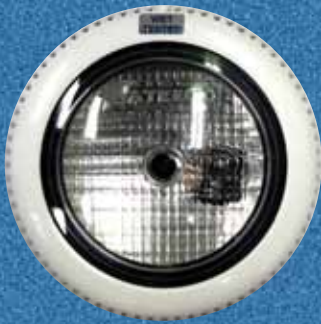

Waterco Diameter 220mm



Waterco Britestream Diameter 220mm



Swimworld Diameter 250mm



Stroud SM400 Diameter 250mm\*



Filtrite Diameter 250mm\*



Sunline/Rivendale Diameter 230mm

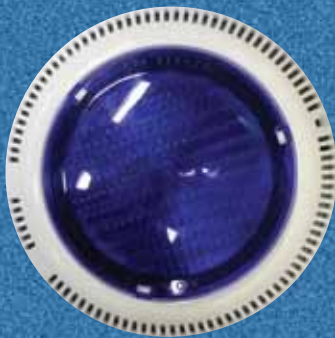

Spa Electrics SE3M Diameter 235mm

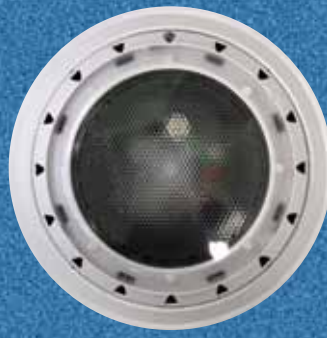

Spa Electrics Diameter 200mm



Autumn Solar Slim 180 Diameter 220mm



Emaux E-Lumen Diameter 261mm



Magic Pool Products Diameter 236mm



Aqua-Quip Halogen Diameter 230mm

\*APL075 Locating Bar Kit required

# RETRO-FIT LED POOL LIGHTS – EVO SERIES NICHE LIGHTS

Aqua-Quip Evo Series LED Pool Lights (Evo2, EvoFG and EvoMAX) in conjunction with varying adaptor plates allow replacement of the following brands of niche/recessed pool lights:

Each Aqua-Quip light is available in a choice of fixed colours of blue, white and green or multi-colour.

## PAL 2000 Concrete

Retro-fit with: **Aqua-Quip EvoFG**

ORDER CODE	DESCRIPTION
<b>ASR 111</b>	BLUE LED – PAL Concrete Retro
<b>ASR 112</b>	WHITE LED – PAL Concrete Retro
<b>ASR 113</b>	GREEN LED – PAL Concrete Retro
<b>ASR 114</b>	MULTI-COLOUR LED – PAL Concrete Retro

## PAL 2000 Fibreglass

Retro-fit with: **Aqua-Quip EvoFG**

ORDER CODE	DESCRIPTION
<b>ASR 121</b>	BLUE LED – PAL Fibreglass Retro
<b>ASR 122</b>	WHITE LED – PAL Fibreglass Retro
<b>ASR 123</b>	GREEN LED – PAL Fibreglass Retro
<b>ASR 124</b>	MULTI-COLOUR LED – PAL Fibreglass Retro

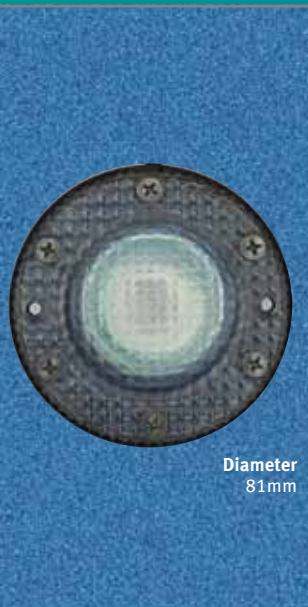

Diameter  
81mm



## Spa Electrics EM (ATOM) Series Concrete

Retro-fit with: **Aqua-Quip EvoFG**

ORDER CODE	DESCRIPTION
<b>ASR 131</b>	BLUE LED – Spa Elec. EM Concrete Retro
<b>ASR 132</b>	WHITE LED – Spa Elec. EM Concrete Retro
<b>ASR 133</b>	GREEN LED – Spa Elec. EM Concrete Retro
<b>ASR 134</b>	MULTI-COLOUR LED – Spa Elec. EM Concrete Retro

## Spa Electrics EM Series Fibreglass

Retro-fit with: **Aqua-Quip EvoFG**

ORDER CODE	DESCRIPTION
<b>ASR 141</b>	BLUE LED – Spa Elec. EM Fibreglass Retro
<b>ASR 142</b>	WHITE LED – Spa Elec. EM Fibreglass Retro
<b>ASR 143</b>	GREEN LED – Spa Elec. EM Fibreglass Retro
<b>ASR 144</b>	MULTI-COLOUR LED – Spa Elec. EM Fibreglass Retro



Diameter  
210mm



# RETRO-FIT LED POOL LIGHTS – EVO SERIES NICHE LIGHTS

## Autumn Solar – Concrete large

Retro-fit with: Aqua-Quip EvoFG

ORDER CODE	DESCRIPTION
<b>ASR 171</b>	BLUE LED – Autumn Solar Concrete Retro
<b>ASR 172</b>	WHITE LED – Autumn Solar Concrete Retro
<b>ASR 173</b>	GREEN LED – Autumn Solar Concrete Retro
<b>ASR 174</b>	MULTI-COLOUR LED – Autumn Solar Concrete Retro



Dia  
200mm



## Autumn Solar – Concrete small

Retro-fit with: Aqua-Quip EvoFG

ORDER CODE	DESCRIPTION
<b>ASR 171</b>	BLUE LED – Autumn Solar Concrete Retro
<b>ASR 172</b>	WHITE LED – Autumn Solar Concrete Retro
<b>ASR 173</b>	GREEN LED – Autumn Solar Concrete Retro
<b>ASR 174</b>	MULTI-COLOUR LED – Autumn Solar Concrete Retro



Dia  
140mm



## Aqua De-Light Concrete & Fibreglass

Retro-fit with: Aqua-Quip EvoFG

ORDER CODE	DESCRIPTION
<b>ASR 151</b>	BLUE LED – Aqua De-Light Retro (Concrete and Fibreglass)
<b>ASR 152</b>	WHITE LED – Aqua De-Light Retro (Concrete and Fibreglass)
<b>ASR 153</b>	GREEN LED – Aqua De-Light Retro (Concrete and Fibreglass)
<b>ASR 154</b>	M/C LED – Aqua De-Light Retro (Concrete and Fibreglass)



Dia  
120mm



## Varimode Concrete & Fibreglass

Retro-fit with: Aqua-Quip EvoFG

ORDER CODE	DESCRIPTION
<b>ASR 181</b>	BLUE LED – Varimode Retro (Concrete and Fibreglass)
<b>ASR 182</b>	WHITE LED – Varimode Retro (Concrete and Fibreglass)
<b>ASR 183</b>	GREEN LED – Varimode Retro (Concrete and Fibreglass)
<b>ASR 184</b>	MULTI-COLOUR LED – Varimode Retro (Concrete and Fibreglass)



Dia  
115mm



## Astral CalidoRay Concrete

Retro-fit with: Aqua-Quip EvoFG

ORDER CODE	DESCRIPTION
<b>ASR 191</b>	BLUE LED – PAL Concrete Retro
<b>ASR 192</b>	WHITE LED – PAL Concrete Retro
<b>ASR 193</b>	GREEN LED – PAL Concrete Retro
<b>ASR 194</b>	MULTI-COLOUR LED – PAL Concrete Retro



Diameter  
81mm



## Astral CalidoRay Fibreglass

Retro-fit with: Aqua-Quip EvoFG

ORDER CODE	DESCRIPTION
<b>ASR 201</b>	BLUE LED – Astral CalidoRay Fibreglass Retro
<b>ASR 202</b>	WHITE LED – Astral CalidoRay Fibreglass Retro
<b>ASR 203</b>	GREEN LED – Astral CalidoRay Fibreglass Retro
<b>ASR 204</b>	MULTI-COLOUR LED – Astral CalidoRay Fibreglass Retro

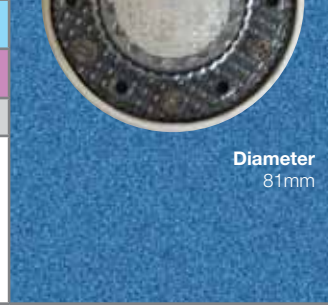

Diameter  
81mm



# RETRO-FIT LED POOL LIGHTS – EVO SERIES NICHE LIGHTS

## Astral Mini Dichro Concrete

Retro-fit with: **Aqua-Quip EvoFG**

ORDER CODE	DESCRIPTION
<b>ASR 211</b>	BLUE LED – Astral Mini-Dichro Concrete Retro
<b>ASR 212</b>	WHITE LED – Astral Mini-Dichro Concrete Retro
<b>ASR 213</b>	GREEN LED – Astral Mini-Dichro Concrete Retro
<b>ASR 214</b>	MULTI-COLOUR LED – Astral Mini-Dichro Conc. Retro



Dia  
96mm



## Hunza Concrete

Retro-fit with: **Aqua-Quip EvoFG**

ORDER CODE	DESCRIPTION
<b>ASR 221</b>	BLUE LED – Hunza Concrete Retro
<b>ASR 222</b>	WHITE LED – Hunza Concrete Retro
<b>ASR 223</b>	GREEN LED – Hunza Concrete Retro
<b>ASR 224</b>	MULTI-COLOUR LED – Hunza Concrete Retro



Dia  
125mm



## Waterco Slim 90 Fibreglass

Retro-fit with: **Aqua-Quip EvoFG**

ORDER CODE	DESCRIPTION
<b>ASR 161</b>	BLUE LED – WCO/SLIM90 Fibreglass Retro
<b>ASR 162</b>	WHITE LED – WCO/SLIM90 Fibreglass Retro
<b>ASR 163</b>	GREEN LED – WCO/SLIM90 Fibreglass Retro
<b>ASR 164</b>	MULTI-COLOUR LED – WCO/SLIM90 F'glass Retro



Dia  
97mm



## Sunline/Rivendale Concrete & Fibreglass

Retro-fit with: **Aqua-Quip EvoFG**

ORDER CODE	DESCRIPTION
<b>ASR 231</b>	BLUE LED – Sunline Retro (Concrete and Fibreglass)
<b>ASR 232</b>	WHITE LED – Sunline Retro (Concrete and Fibreglass)
<b>ASR 233</b>	GREEN LED – Sunline Retro (Concrete and Fibreglass)
<b>ASR 234</b>	MULTI-COLOUR – Sunline Retro (Concrete and Fibreglass)



Dia  
209mm



## Waterco Britestream Concrete

Retro-fit with: **Aqua-Quip EvoMAX**

ORDER CODE	DESCRIPTION
<b>ASR 421</b>	BLUE LED – WCO/Britestream Concrete Retro
<b>ASR 422</b>	WHITE LED – WCO/Britestream Concrete Retro
<b>ASR 423</b>	GREEN LED – WCO/Britestream Concrete Retro
<b>ASR 424</b>	MULTI-COLOUR LED – WCO/Britestream Concrete Retro



Dia  
166mm



## Spa Electrics WN (QUANTUM) Series Concrete & Fibreglass

Retro-fit with: **Aqua-Quip EvoMAX** *Specify concrete or fibreglass when ordering*

ORDER CODE	DESCRIPTION
<b>ASR 411</b>	BLUE LED – Spa Electrics WN Retro (Concrete and Fibreglass)
<b>ASR 412</b>	WHITE LED – Spa Electrics WN Retro (Concrete and Fibreglass)
<b>ASR 413</b>	GREEN LED – Spa Electrics WN Retro (Concrete and Fibreglass)
<b>ASR 414</b>	MUL-COL LED – Spa Electrics WN Retro (Concrete and Fibreglass)

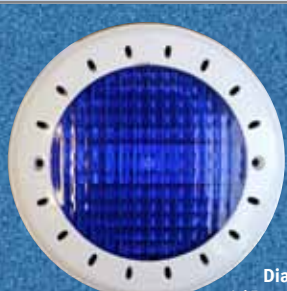

Dia  
165mm



# RETRO-FIT LED POOL LIGHTS – EVO SERIES NICHE LIGHTS

## Astral Delta & ARC Concrete & Fibreglass

Retro-fit with: **Aqua-Quip EvoMAX**

ORDER CODE	DESCRIPTION
<b>ASR 441</b>	BLUE LED – Astral Delta/Arc Concrete and Fibreglass Retro
<b>ASR 442</b>	WHITE LED – Astral Delta/Arc Concrete and Fibreglass Retro
<b>ASR 443</b>	GREEN LED – Astral Delta/Arc Concrete and Fibreglass Retro
<b>ASR 444</b>	MULTI-COLOUR LED – Astral Delta/Arc Concrete and Fibreglass Retro



Dia  
174mm



## Aqua-Star Halogen & Spectrum MK1 Concrete

Retro-fit with: **Aqua-Quip EvoMAX**

ORDER CODE	DESCRIPTION
<b>ASR 431</b>	BLUE LED – Aqua-Star and Spectrum Concrete Retro MAX
<b>ASR 432</b>	WHITE LED – Aqua-Star and Spectrum Concrete Retro MAX
<b>ASR 433</b>	GREEN LED – Aqua-Star and Spectrum Concrete Retro MAX
<b>ASR 434</b>	M/C LED – Aqua-Star and Spectrum Concrete Retro MAX



Diameter  
135mm



## Aqua-Star Halogen & Spectrum MK1 Concrete

Retro-fit with: **Aqua-Quip Evo2**

ORDER CODE	DESCRIPTION
<b>ASR 101</b>	BLUE LED – Aqua-Star & Spectrum Concrete Retro
<b>ASR 102</b>	WHITE LED – Aqua-Star & Spectrum Concrete Retro
<b>ASR 103</b>	GREEN LED – Aqua-Star & Spectrum Concrete Retro
<b>ASR 104</b>	MULTI-COL LED – Aqua-Star & Spectrum Concrete Retro



Dia  
133mm



## Lumascape Concrete

Retro-fit with: **Aqua-Quip Evo2**

ORDER CODE	DESCRIPTION
<b>ASN 501</b>	BLUE LED – Lumascape Concrete Retro
<b>ASN 502</b>	WHITE LED – Lumascape Concrete Retro
<b>ASN 503</b>	GREEN LED – Lumascape Concrete Retro
<b>ASN 504</b>	MULTI-COLOUR LED – Lumascape Concrete Retro



Dia  
147mm



## Poolstore Concrete

Retro-fit with: **Aqua-Quip Evo2**

ORDER CODE	DESCRIPTION
<b>ASN 511</b>	BLUE LED – Poolstore Concrete Retro
<b>ASN 512</b>	WHITE LED – Poolstore Concrete Retro
<b>ASN 513</b>	GREEN LED – Poolstore Concrete Retro
<b>ASN 514</b>	MULTI-COLOUR LED – Poolstore Concrete Retro



Dia  
135mm



## Aqua-Star Halogen & Spectrum MK1 F'glass

Retro-fit with: **Aqua-Quip Evo2**

ORDER CODE	DESCRIPTION
<b>ASN 221</b>	BLUE LED – Aqua-Star and Spectrum Fibreglass Retro
<b>ASN 222</b>	WHITE LED – Aqua-Star and Spectrum Fibreglass Retro
<b>ASN 223</b>	GREEN LED – Aqua-Star and Spectrum Fibreglass Retro
<b>ASN 224</b>	MULTI-COL – Aqua-Star and Spectrum Fibreglass Retro

# TRANSFORMERS



## TRANSFORMERS

	CODE	DESCRIPTION
<b>NEW</b>	<b>APL 511N</b>	12 VOLT – 1 x 30VA OUTPUT – PLUG IN
<b>NEW</b>	<b>APL 512N</b>	12 VOLT – 2 x 30VA OUTPUTS – PLUG IN
<b>NEW</b>	<b>APL 514N</b>	12 VOLT – 4 x 30VA OUTPUTS – PLUG IN

**Aqua-Quip plug-in transformers deliver a safe extra low voltage 12V supply to operate Aqua-Quip’s range of LED Pool Lights.**

**To comply with AS/NZS 3000:2007 Clause 6.3.4.5, for new pool construction, each underwater light must be supplied from an individual isolation transformer or an individual winding on an isolation transformer.**

**To comply with this legislation and to facilitate the simple installation of multiple LED pool lights, Aqua-Quip supplies transformers with either 1, 2 or 4 individual windings.**



APL 511N runs one Aqua-Quip LED light.



APL 512N runs up to two Aqua-Quip LED lights.



APL 514N runs up to four Aqua-Quip LED lights.

## VIVID 360 POOL REPLACEMENT LED

***New to the USA market, the Vivid 360 Replacement Pool Light fits into a variety of standard swimming pool niches. Designed and made in Australia by Aqua-Quip.***

*The unique patented Plug Kit allows for simple connection to the pool light – making installation effortless.*

*The brightness and colour-blending is unsurpassed and allows the state-of-the-art LED array to operate efficiently and reliably.*

*Vivid 360 Replacement Pool Light can be connected to a variety of controllers, and safety is ensured due to its UL Listing.*



FILE: E476341

**Vivid 360**  
POOL REPLACEMENT LED  
POOL NICHE



15

# PHOTOMETRY

Lumen (lm) – Is the measure of the total amount of visible light emitted by a luminaire.

Luminous Efficacy (lm/W) – is a measure of the efficiency with which a luminaire provides visible light from electricity.

## Evo2 and EvoFG

## EvoMAX

## QC Surface Mounted

WHITE

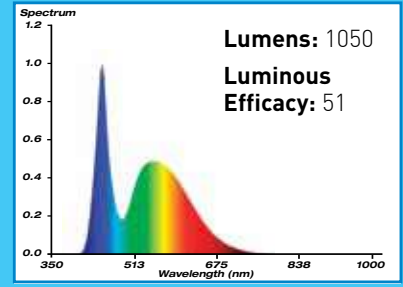
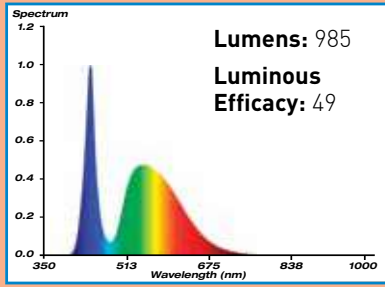
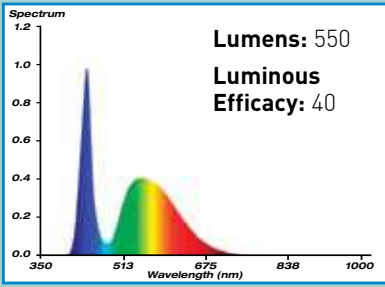

BLUE

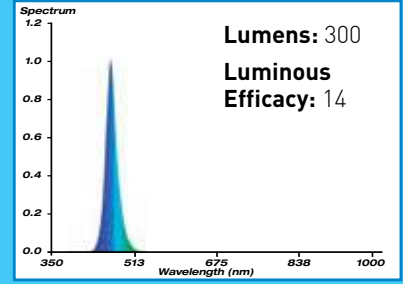
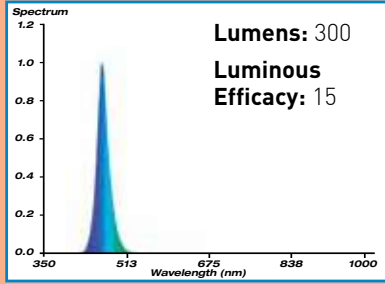
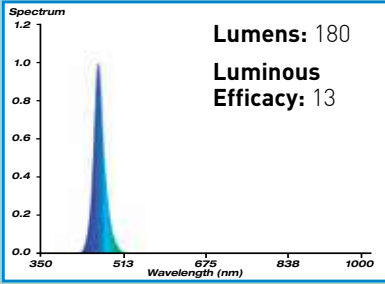

RED

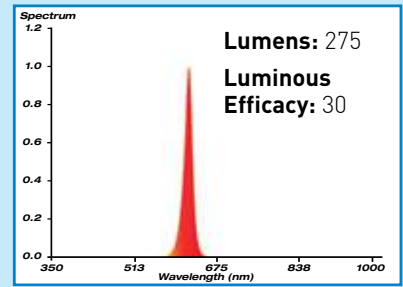
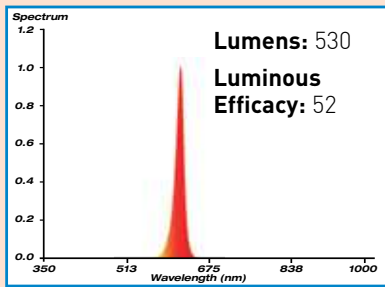
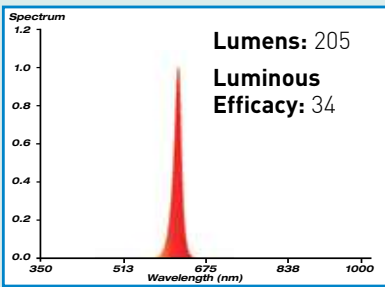

GREEN

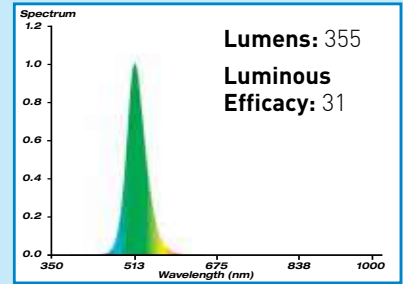
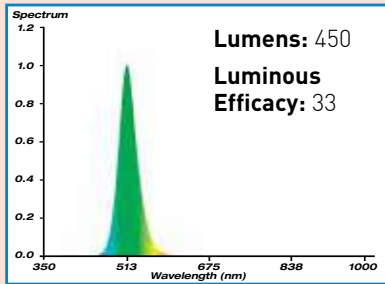
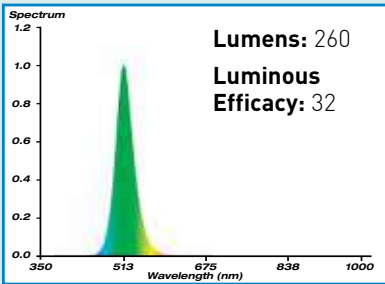

BLUE

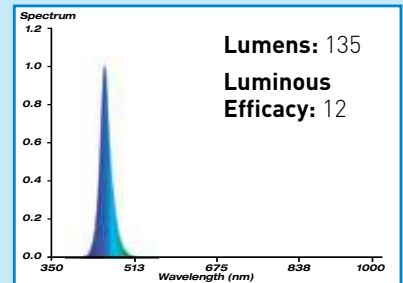
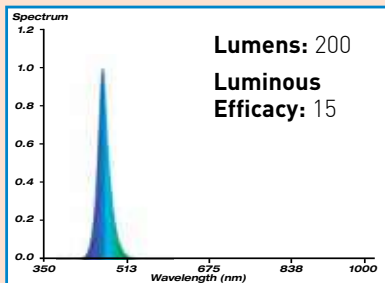
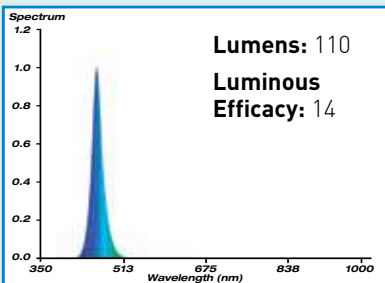

WHITE

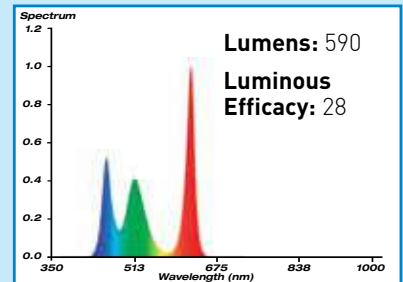
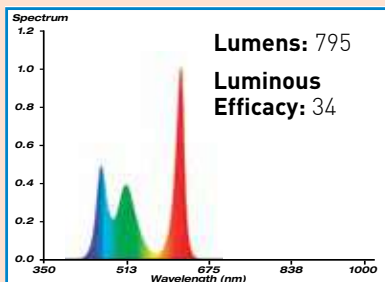
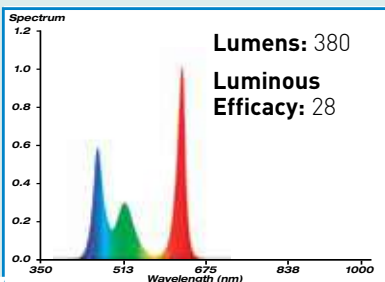

FIXED COLOURS

MULTI-COLOUR



*For a guaranteed spotless pool...*

*Jet-Vac... the finest pool cleaner in the world is now made in Australia.*

*The huge 115mm throat picks up twigs, large leaves, dirt, even golf balls and goggles!*

*Large capacity bag compacts up to 3.5 litres of rubbish.*

*Now available in graphite.*



**NEW**

Now available in graphite.



*Jet-Vac features forward and reverse cycles to ensure complete pool coverage on any surface without getting stuck in corners.*

*Propulsion and cleaning is achieved purely by jets of water.*

*Wheels are free spinning and are not connected to turbines, drive belts or gears. Jet-Vac requires a dedicated plumbing line and is powered by the AquaBoost Booster Pump.*

## JET-VAC POOL CLEANERS

CODE	DESCRIPTION
LJV 101	JET-VAC HEAD AND HOSE SET JV105AU
<b>NEW</b> LJV101G	GRAPHITE JET-VAC HEAD AND HOSE SET JV105AUG
LJV 104	JET-VAC HEAD JV109AU
LJV 105	JET-VAC HOSE SET COMPLETE JV209AU
LJV 108	JET-VAC PLATINUM PACKAGE (includes Jet-Vac Head and Hose, Booster Pump and Flow Control Timer), extended warranty



Australian Made

**JET-VAC**  
AUTOMATIC POOL CLEANERS

# SALTMATE CHLORINATOR TWISTER

***Saltmate Saltwater Chlorinators are designed to save the pool owner money, time and effort while setting new standards in terms of materials, quality and functionality.***

*Constructed with a solid plate cell design, water resistant case and robust power supply to ensure economical and trouble free pool sanitisation.*



Australian Made



## ***Twister – power steering for suction pool cleaners.***

**Twister continually rotates the direction of the hose – effectively steering your suction pool cleaner out of awkward corners to ensure a constantly random and thorough cleaning pattern, without getting stuck in corners.**

**Problem:** many suction pool cleaners get stuck in corners, others constantly follow a repetitive pattern around the pool. Either way, you end up with a dirty pool.

**Solution:** Simply install a Twister. Twister continually changes the direction of the hose – power steering your pool cleaner out of awkward corners to ensure a constantly random and thorough cleaning pattern.

- *Steers suction pool cleaners out of corners.*
- *Promotes random and thorough pool cleaning.*
- *Simple to install, fits to existing pool hose.*



Australian Made



Exported to USA

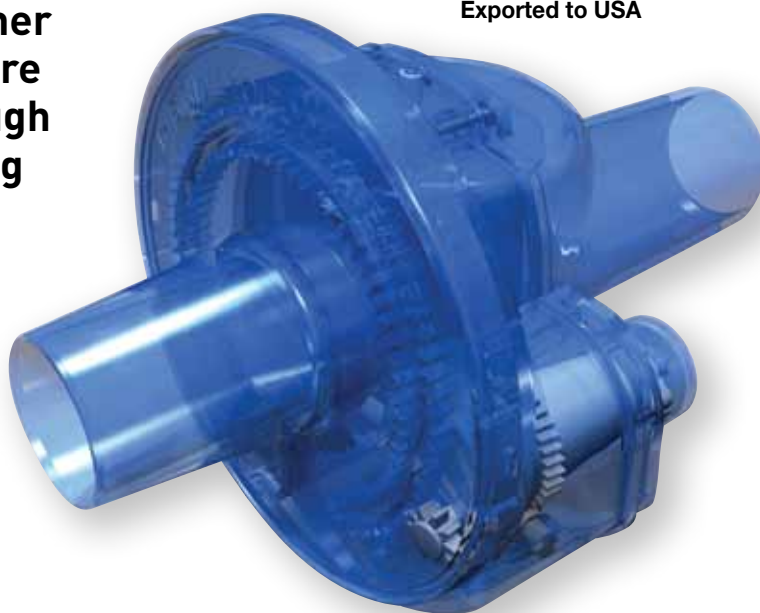

twister®  
~~~~~

***The Aqua-Quip Flow Control Pro Series Timer eliminates the possibility of the booster pump running dry of water as a result of incorrect synchronisation with the pool pump.***

- **Reduces wear and tear on the pool cleaner and saves expensive pump repairs.**
- **Saves power consumption by limiting the operating hours of the booster pump.**

*The Aqua-Quip Flow Control Pro Series Timer can be used for a variety of applications where water flow is required to switch on an auxiliary electrical device.*

*The Aqua-Quip Flow Control Pro Series Timer with its integrated flow switch is significantly more reliable and much simpler than installing two separate time clocks.*

*New setting allows the user to set run times to synchronise with variable speed pumps.*

*Aqua-Quip's 2 year warranty provides the user ultimate peace of mind.*



Flow Control Timer Box is plugged into a constant 240v power point. Booster Pump plugs into the Flow Control Timer Box to ensure that it only operates whilst the pool pump is running.



**Australian Made**

## ***Aqua-Quip Booster Pump***



- ***proven, reliable performance***
- ***runs all pressure pool cleaners***

*Compact and simple to install, Aqua-Quip's Booster Pump operates quietly and is the perfect partner for the Jet-Vac Automatic Pool Cleaner.*

*Robust design ensures a long life with minimal maintenance.*

*Supplied with the option of Flexible Plumbing Kit or PVC Barrel Unions.*

# DISTRIBUTORS

## AUSTRALIA:

|                          |                           |              |                                                                                      |
|--------------------------|---------------------------|--------------|--------------------------------------------------------------------------------------|
| <b>NATIONALLY</b>        | ZODIAC                    | 1300 763 021 | <a href="http://www.zodiac.com.au">www.zodiac.com.au</a>                             |
| <b>QUEENSLAND</b>        | RAINBOW POOL PRODUCTS     | 07 3849 5385 | <a href="mailto:info@rainbowpoolproducts.com.au">info@rainbowpoolproducts.com.au</a> |
|                          | POOL SYSTEMS              | 1300 366 020 | <a href="mailto:sales@poolsystems.com.au">sales@poolsystems.com.au</a>               |
| <b>NEW SOUTH WALES</b>   | AQUA-QUIP                 | 02 9643 8338 | <a href="mailto:aqua@aquaquip.com.au">aqua@aquaquip.com.au</a>                       |
| <b>VICTORIA</b>          | RELTECH AUSTRALIA PTY LTD | 03 9459 3838 | <a href="mailto:office@reltech.com.au">office@reltech.com.au</a>                     |
| <b>WESTERN AUSTRALIA</b> | CHADSON ENGINEERING       | 08 9344 3611 | <a href="mailto:sales@chadson.com.au">sales@chadson.com.au</a>                       |
| <b>SOUTH AUSTRALIA</b>   | POOL SYSTEMS              | 1300 366 020 | <a href="mailto:sales@poolsystems.com.au">sales@poolsystems.com.au</a>               |

## NEW ZEALAND:

|                   |             |                 |                                                                          |
|-------------------|-------------|-----------------|--------------------------------------------------------------------------|
| <b>NATIONALLY</b> | ECO SPRINGS | +64 09 421 1463 | <a href="http://www.ecospringspools.co.nz">www.ecospringspools.co.nz</a> |
|-------------------|-------------|-----------------|--------------------------------------------------------------------------|

## USA:

|                                |                           |                |                                                                  |
|--------------------------------|---------------------------|----------------|------------------------------------------------------------------|
| <b>Jet-Vac Pool Cleaner</b>    | POOLCORP                  | (985) 892 5521 | <a href="http://www.poolcorp.com">www.poolcorp.com</a>           |
| <b>Pool Lights (UL Listed)</b> | BLUE SQUARE MANUFACTURING | (480) 612 6880 | <a href="http://www.bluesquaremfg.com">www.bluesquaremfg.com</a> |



# AQUA QUIP

AUTOMATIC POOL CLEANERS (AUSTRALIA) PTY LTD  
40 PERCY STREET, AUBURN 2144  
NSW AUSTRALIA  
P: +612 9643 8338  
F: +612 9643 8448  
E: [aqua@aquaquip.com.au](mailto:aqua@aquaquip.com.au)  
W: [www.aquaquip.com.au](http://www.aquaquip.com.au)

*Details and Specifications are correct as at August, 2018 and are subject to change at any time.*